A

Elastimold®/Fisher Pierce®

Cable accessories



200 A loadbreak elbows

Overview

—
01 15/25 kV class
—
02 15/25 kV class

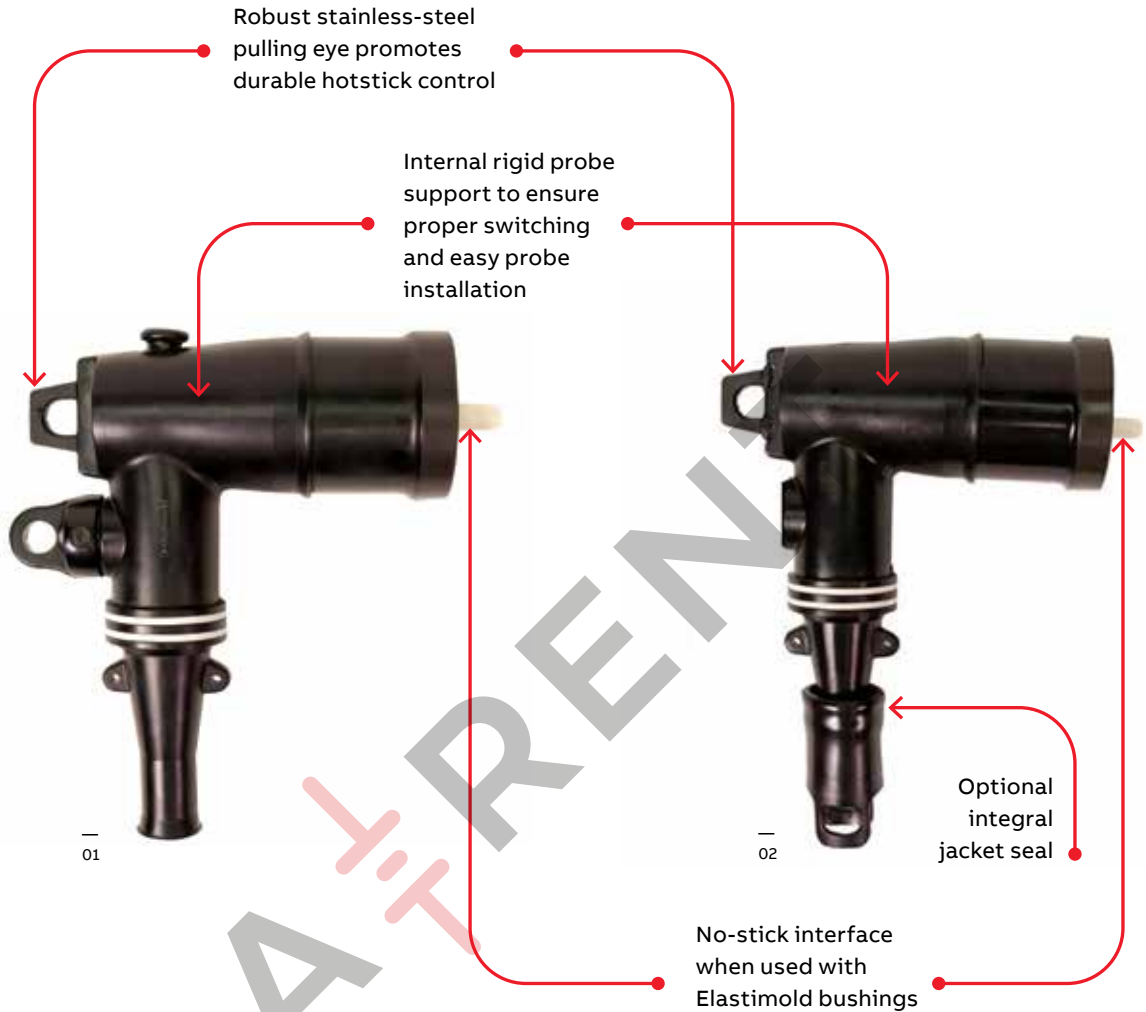

Ratings overview

See pages A4–A5 for complete information, including switching and fault close ratings.

Current ratings

- 200 A continuous
- 10 kA sym. 10 cycles

Voltage ratings

- 15 kV class
- 8.3 kV phase-to-ground
- 14.4 kV phase-to-phase
- 95 kV BIL
- 34 kV AC withstand
- 53 kV DC withstand
- 11 kV corona extinction

25 kV class

- 15.2 kV phase-to-ground
- 26.3 kV phase-to-phase
- 125 kV BIL
- 40 kV AC withstand
- 78 kV DC withstand
- 19 kV corona extinction

35 kV class

- 21.1 kV phase-to-ground
- 36.6 kV phase-to-phase
- 150 kV BIL
- 50 kV AC withstand
- 103 kV DC withstand
- 26 kV corona extinction

200 A loadbreak separable connectors

Components

Cable to equipment connections

ABB offers the complete package of underground cable accessories – everything you need to connect, ground, splice, terminate and protect underground

cable from 5 kV to 138 kV – along with solid dielectric switchgear in compact, modular designs that fit easily into tight vaults.

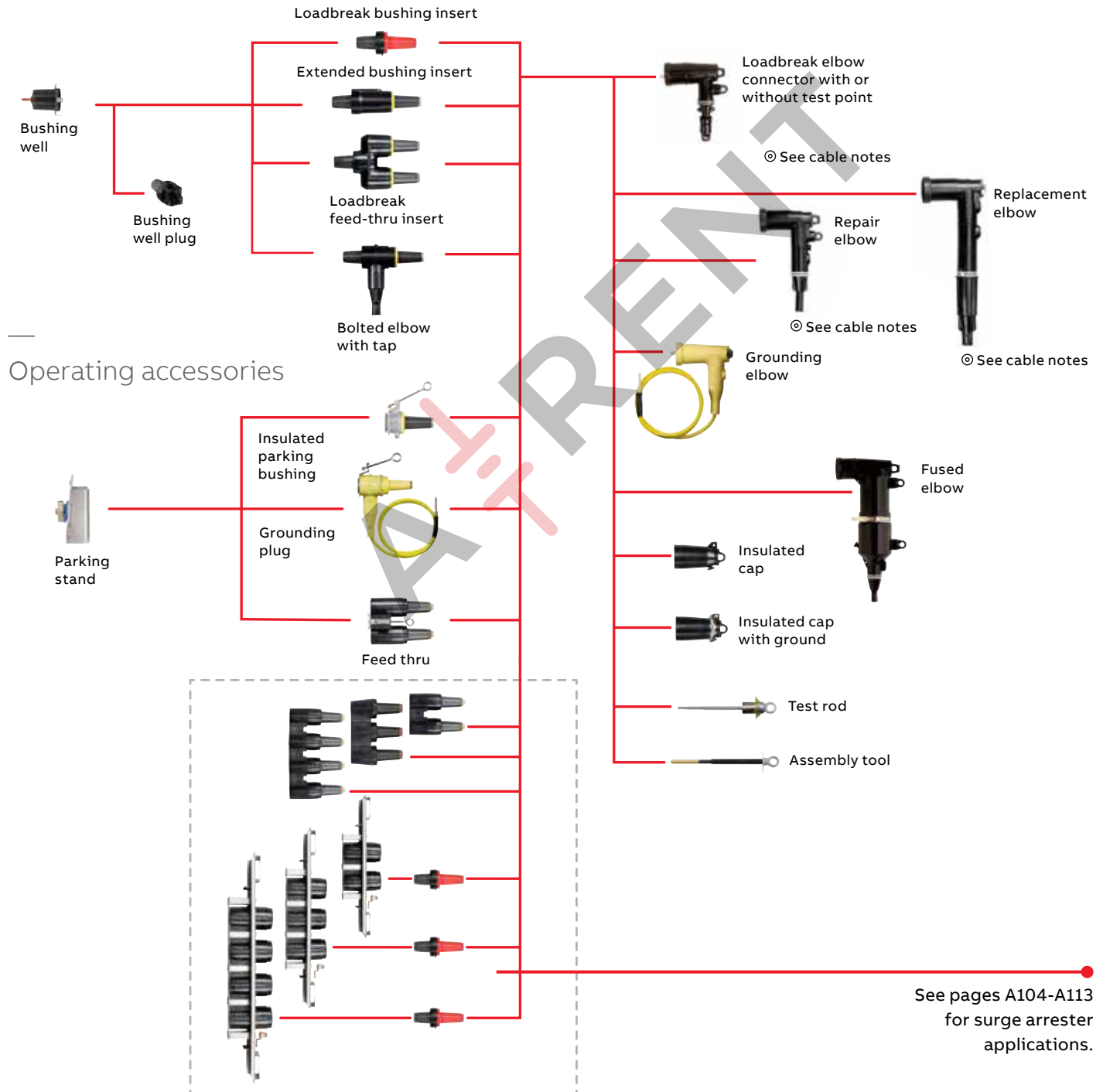

200 A loadbreak separable connectors

Loadbreak elbows

Image (not to scale)	Description	Voltage class (kV)	Cat. no.	Notes
	Elbow connector without test point	15	161LR-W5X Use tables W1 and X1	N2, 3, 4, 5
		25	261LR-W5X Use tables W1 and X1	N2, 3, 4, 5
		35	375LR-W5X Use tables W3 and X2	N2, 3, 5
	Elbow connector with test point	15	162LR-W5X Use tables W1 and X1	N2, 3, 4, 5, 23
		25	262LR-W5X Use tables W1 and X1	N2, 3, 4, 5, 23
		35	376LR-W5X Use tables W3 and X2	N2, 3, 5, 23
	Jacket seal elbow connector without test point	15	161LRJS-W5X Use tables W1 and X1	N2, 19
		25	261LRJS-W5X Use tables W1 and X1	N2, 19
	Jacket seal elbow connector with test point	15	162LRJS-W5X Use tables W1 and X1	N2, 19, 23
		25	262LRJS-W5X Use tables W1 and X1	N2, 19, 23
	Repair elbow connector	15	167ELR-W5X Use tables W5 and X1	N5, 10, 18
		25	273ELR-W5X Use tables W5 and X1	N5, 10, 18
	Repair elbow connector with test point	15	168ELR-W5X Use tables W5 and X1	N5, 10, 18, 23
		25	274ELR-W5X Use tables W5 and X1	N5, 10, 18, 23
	Replacement elbow	15	167RLR-W5X Use tables W4 and X1	N5, 11, 13
		25	273RLR-W5X Use tables W2 and X1	N5, 11, 13
	Replacement elbow with test point	15	168RLR-W5X Use tables W4 and X1	N5, 11, 13, 23
		25	274RLR-W5X Use tables W2 and X1	N5, 11, 13, 23
	Direct test elbow connector	15	161DLR-W5X Use tables W1 and X1	N2, 5, 21
		25	261DLR-W5X Use tables W1 and X1	N2, 5, 21
	Direct test repair elbow connector	15	167DELR-W5X Use tables W5 and X1	N5, 10, 18, 21
		25	273DELR-W5X Use tables W5 and X1	N5, 10, 18, 21
	Direct test repair elbow connector with test point	15	168DELR-W5X Use tables W5 and X1	N5, 10, 18, 21, 23 3
		25	274DELR-W5X Use tables W5 and X1	N5, 10, 18, 21, 2

N1. Copper lug for use on COPPER CONDUCTOR ONLY.

N2. W5X indicates that the catalog number includes 02500X long bi-metal compression lug as standard. For an all-copper lug, replace W5X with W2X in Table X1 to specify the all-copper 02702X lug.

N3. Also available as housing only. Specify: 161BLR-W; 261BLR-W; 375BLR-W; 162BLR-W; 262BLR-W; 376BLR-W.

N4. Also available as elbow with insert combination. Specify: 161A4-WX; 261A4-WX; 162A4-WX; 262A4-WX.

N5. Also available with 200ECS jacket seal included. Add - "S" suffix to catalog number (highly recommended).

N10. Repair elbow has extended length contact and elbow housing resulting in a net gain of 3/4" in length.

N11. Replacement elbow has extended-length contact and elbow housing resulting in a net gain of 8/16" in length.

N13. Includes long bi-metal contact 00400X.

N18. Includes 02509X long bi-metal contact.

N19. Includes built-in jacket seal. Also available as housing only – specify: 161BLRJS-W, 162BLRJS-W, 261BLRJS-W or 262LRJS-W. Also available as elbow with insert combination – specify: 161JSA4-W5X, 162JSA4-W5X, 261JSA4-W5X or 262JSA4-W5X.

N21. Direct test connectors, along with a 200TC-X series meter adapter, a properly rated voltage meter and hot-line stick provide a means for direct conductor voltage testing.

N23. Test point cap catalog number 156-7

Refer to the W and X tables on pages A54–A55 for sizing to cable insulation diameter and conductor size. For cable shield adapters and jacket seals, see pages A44–A45.

200 A loadbreak separable connectors

Loadbreak bushings





















Image (not to scale)	Description	Voltage class (kV)	Cat. no.	Notes
	Grounding plug (1/0 AWG x 6' ground lead)	15	161GP	-
		25	272GP	-
	Grounding elbow (1/0 AWG x 6' ground lead)	15	160GLR	N12
		25/35	370GLR	N12
	Feed-thru	15	164FT	N6, N18
		25	274FT	N6, N18
		35	371FT	N6, N18
		35	373FT	N6, N18
	Feed-thru vertical	15	164FTV	-
		25	274FTV	-
		35	373FTV	-
	Adjustable bracket 2-point feed-thru	15	164FT2-AB	N22
		25	274FT2-AB	N22
		35	373FT2-AB	N22
	Adjustable bracket 3-point feed-thru	15	164FT3-AB	N22
		25	274FT3-AB	N22
		35	373FT3-AB	N22
	Adjustable bracket 4-point feed-thru	15	164FT4-AB	N22
		25	274FT4-AB	N22
		35	373FT4-AB	N22
	Feed-thru well	15/25	K1601WFT	-
	Feed-thru well vertical	15/25	K1601WFTV	-
	Insulated parking bushing	15	161SOP	N20
		25	272SOP	N20
		35	372SOP	N20
	Insulated parking bushing	15	164SOP	N22
		25	274SOP	N22
	Assembly tool	All	200AT	N8
	Bushing well plug	15/25	276BWP	-
		35	M276BWP	-
	Test rod	All	370TR	-
	Bolted elbow with tap	15	167LRT-W5X Use tables W4 and X1	N17
	Bushing insert	15	1601A4	N4, 8
		25	2701A4	N4, 8
		35	3701A4	N6, 20
		35	3701A3	20

Image (not to scale)	Description	Voltage class (kV)	Cat. no.	Notes
	Extended bushing insert	15	1601EA4	N8
		25	2701EA4	N8
	Feed-thru insert	15	1602A3R	N16
		25	2702A1	N16
		35	3702A1	N6, 16
	Insulated cap	15	160DR	N9
	Insulated cap with ground	15	160DRG	N9
		15	167DRG	N7, 9
		25	273DRG	N7, 9
		35	375DRG	N7, 9
	Insulated cap with ground and test point	15	168DRG	N7
		25	274DRG	N7
		35	376DRG	N7

N4. Also available as elbow with insert combination. Specify: 161A4-WX; 261A4-WX; 162A4-WX; 262A4-WX.

N6. Rated for single-phase applications only.

N7. Equipped with insulated cuff.

N8. Includes internal torquing feature using 200AT assembly tool.

N9. Also available without probe. Specify "A" suffix - Example: 273DRGA.

N12. Rated for 25 kV thru 35 kV applications.

N16. Fully rotatable for 360° positioning. Includes bail assembly to secure feed-thru insert to bushing well.

N17. Includes 02800X bi-metal contact.

N18. Includes 02509X long bi-metal contact.

N20. Includes a black vent ring.

N22. With stainless steel bracket.

Refer to the W and X tables on pages A54–A55 for sizing to cable insulation diameter and conductor size. For cable shield adapters and jacket seals, see pages A44–A45.

600 A deadbreak separable connectors

600 series deadbreak components

600 Series deadbreak elbows, straight receptacles, junctions, vault stretchers and accessories are used to connect equipment and cable on primary feeder and network circuits. Designs accommodate large conductors and feature bolted connections and deadfront modular construction for maximum reliability, performance and versatility. De-energized connectors can be quickly and easily connected and disconnected using standard hand tools and equipment in accordance with accepted operating practices. Optional accessories allow visible external separation, bypass, isolation, dead-ending, grounding and testing as well as adding taps, surge arresters and circuit protection. Hotstick-operable and separable joint systems are shown on pages A22–A28.

Spiking aid

When spiking a medium voltage cable near a separable connector, the Elastimold spiking aid is a specially designed product to reduce outage time and cost. Medium voltage cable is spiked as a means to ensure the circuit is de-energized where there is no sectionalizing device, direct testing means or provision for grounding.

GAD

When available fault currents exceed 10 kA in underground systems, the Elastimold GAD may provide a solution. The Elastimold GAD is rated 25 kA and installs in the rear interface of a 600 series elbow connector (T-body). The GAD is normally covered and insulated with an insulating cap that contains capacitive test and a hotstick operating band. Once the circuit is opened at a disconnecting device, the test point cap is removed with a hotstick, and then using an appropriate capacitive test point meter, the test point is checked for voltage. The insulating cap is then removed with a hotstick and a high voltage meter is used to confirm the de-energized state before a ground cable is connected.

Ratings overview

See pages A4–A5 for complete information.

Current ratings

(Prefixes: 650, K650, K651, K655, K656, 750, 755, 756 and 03700)

- 600 A continuous
- 25 kA sym., 10 cycles

(Prefixes 675, K671, K675, K676, 775, 776 and 03702)

- 900 A continuous
- 25 kA sym., 10 cycles

Note: 900 A ratings require copper cable and copper current-carrying components.

Voltage ratings

15/25 kV class (5 kV thru 28 kV)

- 16.2 kV phase-to-ground
- 28 kV phase-to-phase
- 140 kV BIL
- 45 kV AC withstand
- 84 kV DC withstand
- 21.5 kV corona extinction

35 kV class

- 21.1 kV phase-to-ground
- 36.6 kV phase-to-phase
- 150 kV BIL
- 50 kV AC withstand
- 103 kV DC withstand
- 26 kV corona extinction

Note: Elastimold has increased the IEEE Standard Production and Design Test levels for 25 kV class products to include 27 kV and 28 kV systems.

- * Tested at 8.3/14.9 kV
- † Tested at 15.2/26.3 kV
- Tested at 21.1/36.6 kV

600 A deadbreak separable connectors

600 series deadbreak components

- * Tested at 8.3/14.9 kV
- † Tested at 15.2/26.3 kV
- Tested at 21.1/36.6 kV

Cable to equipment

See pages A104–A113 for surge arrester applications.



Integral bushing

Cable to cable (using junctions)

See pages A34–A37 for additional junctions

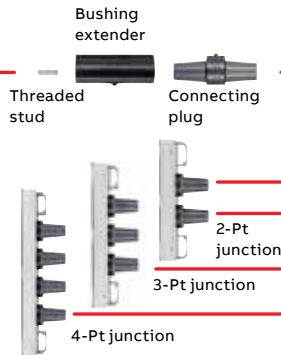

Operating accessories



Straight receptacle

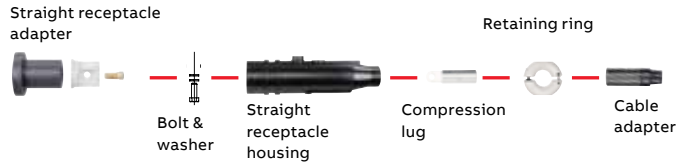



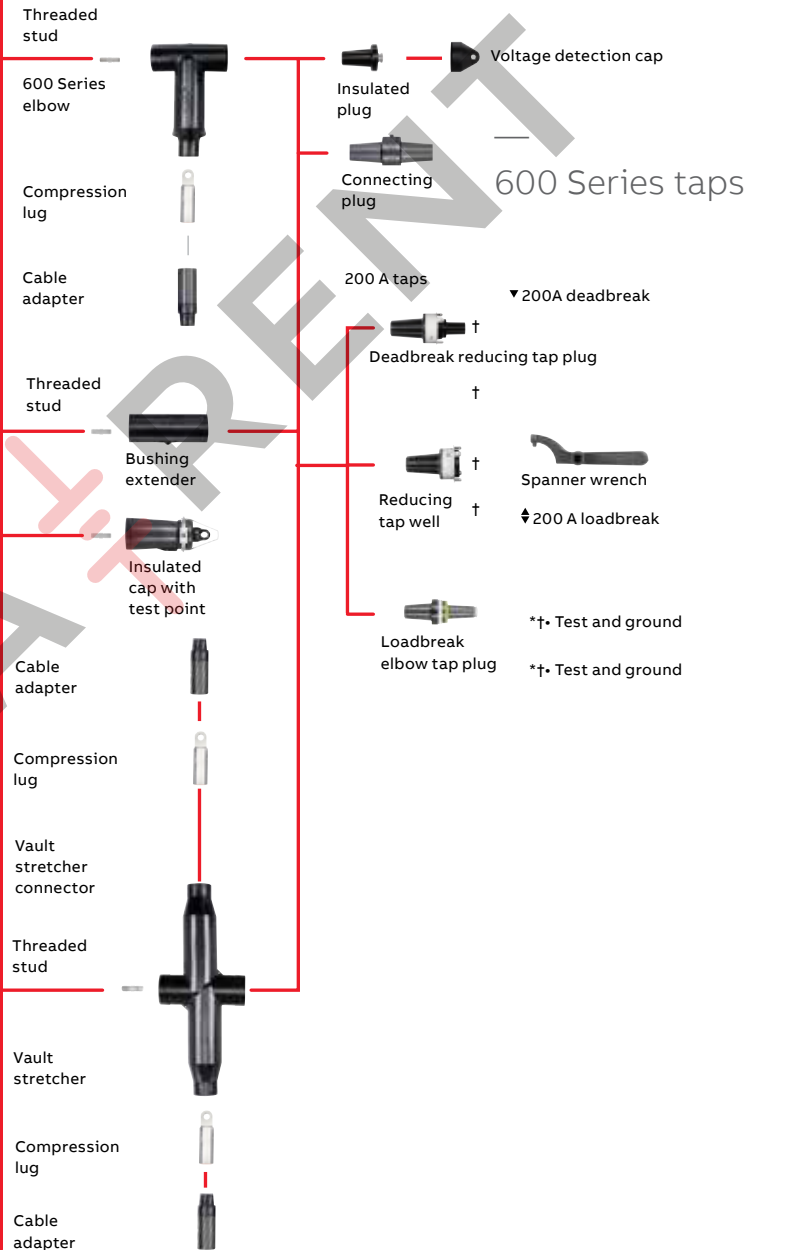







Elbow connector



600 A deadbreak separable connectors

600 A deadbreak elbows

600 A deadbreak elbows

Image (not to scale)	Description	Voltage class (kV)	Cat. no.	Notes
	600 Series elbow (with insulating plug, cap, stud, lug and cable adapter)	15/25	K655LR-W0X Use tables W7 and X6	N1, 2
		35	755LR-W0X Use tables W9 and X6	N1, 2, 15
	600 Series direct test elbow (with insulating plug, cap, stud lug and cable adapter)	15/25	K655DLR-W0X Use tables W7 and X6	N1, 2, 12
		35	755DLR-W0X Use tables W9 and X6	N1, 2, 12, 15
	600 Series elbow with test point (with insulating plug, cap, stud, lug and cable adapter)	15/25	K656LR-W0X Use tables W7 and X6	N1, 2
		35	756LR-W0X Use tables W9 and X6	N1, 2, 15
	600 Series direct test elbow with test point (with insulating plug, cap, stud, lug and cable adapter)	15/25	K656DLR-W0X Use tables W7 and X6	N1, 2, 12
		35	756DLR-W0X Use tables W9 and X6	N1, 2, 12, 15
	600 Series elbow without test point housing only (with stud)	15/25	K655BLR	N1, 3
		35	755BLR	N1, 3, 15
	600 Series elbow with test point housing only (with stud)	15/25	K656BLR	N1, 3
		35	756BLR	N1, 3, 15
	600 Series straight receptacle (with cable adapter, lug and retaining ring)	15/25	K655SR-W0X Use tables W7 and X6	N1, 2, 11
	600 Series direct test straight receptacle elbow	15/25	K655DSR-W0X Use tables W7 and X6	N1, 2, 11, 12
	600 Series straight receptacle housing (lug and cable adapter not included)	15/25	K655BSR	N1,11
	Straight receptacle adapter	15/25	K650SRA	N1, 4
	600 Series vault stretcher (housing only with stud)	15/25 kV	K655BVS	N1, 9
		35 kV	755BVS	N1, 9

N1. For 900 A ratings, substitute 675 for 650 and 655; 676 for 656; K671 for K651; K675 for K650 and K655; K676 for K656; 775 for 750 and 755; 776 for 756 and 2X for 0X in the catalog number. The 900 A rating requires copper current-carrying connector components and copper conductor cable.

N2. Add suffix symbol from page A17 to include cable shield grounding kit and/or cable jacket sealing kit.

N3. Available without the stud by adding "N" to the catalog number.

N4. Straight receptacle adapter is used to connect straight receptacles K655YBSR and K655YSR-W0X (page A33) to equipment bushings.

N5. Aluminum lug for use on aluminum or copper conductors. DO NOT substitute threaded 03600X lug.

N6. Copper lug for use on COPPER CONDUCTOR ONLY.

DO NOT substitute threaded 03602X lug.

N7. Available with the stud factory-assembled by adding "SP" to the catalog number. 675ETP, K675ETP and 775ETP are available as -SP only. The stud is not field removable.

N8. Available with a loose stud by adding suffix "S" to the catalog number.

N9. 600SW spanner wrench is recommended for installation of deadbreak reducing tap plugs and reducing tap wells.

N10. Use 600ATM assembly tool.

N11. 600 Series elbows and straight receptacles with IEEE Std. 386 capacitive test points are available by substituting 656 for 655; K656 for K655; K676 for K675; 756 for 755; 676 for 675; K676 for K675 and 776 for 775 in the catalog number.

N12. Direct test connectors, along with a 200TC-X series meter adapter, a properly rated voltage meter and hot-line stick; provides a means for direct conductor voltage testing.

N13. With stainless steel bracket.

N15. Available with 200 kV BIL adding suffix "-200".





















N16. Bimetallic Lug for use on aluminum or copper conductors. DO NOT substitute threaded 05501X lug

Refer to the W and X tables on pages A54–A55 for sizing to cable insulation diameter and conductor size. For cable shield adapters and jacket seals, see pages A44–A45.

600 A deadbreak separable connectors

600 series deadbreak components

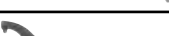
600 A deadbreak accessories

Image (not to scale)	Description	Voltage class (kV)	Cat. no.	Notes
	Cable size adapter	15/25	655CA-W Use tables W7	-
		35	755CA-W Use tables W9	-
	Compression lug	All	03700X Use tables X6	N5
		All	03702X Use tables X6	N6
	Bimetallic compression lug	All	04601XXX Use Table X6	N16
	Epoxy connecting plug	15/25	K650CP	N9
	600 Series elbow and vault stretcher size sensitive kit (cable adapter and lug)	15/25	655CK-W0X Use tables W7 and X6	N2
		35	755CK-W0X Use tables W9 and X6	N2
	Adapter retaining ring	All	650ARR-X Use Table X6	-
	600 Series straight receptacle size sensitive kit (cable adapter, retaining ring and lug)	15/25	655CK-W0X-ARR Use tables W7 and X6	N2
	Bushing extender (with stud)	15/25	K655BE	N1, 3
		35	755BE	N1, 3
	Insulated cap with test point (with stud)	15/25	K656DR	N3, 7
		35	756DR	-
	Insulated cap with test point (with stud) and ground	15/25	K656DRG	N3, 7
		35	756DRG	-
	Insulating plug (with cap)	15/25	K650BIP	N1, 7, 8
		35	750BIP	N1, 7, 8
	Grounding plug (ground lead 2/0 AWG x 30")	15/25	650GP	N1, 7, 8
		35	750GP	N1, 7, 8
	Insulated parking bushing	15/25	K650SOP	N7, 8
		35	750SOP	N7, 8
	Connecting plug	15/25	K651CP	N1, 7, 8, 10
		35	750CP	N1, 7, 8, 10
	Deadbreak reducing tap plug	15/25	K650RTP	N1, 7, 8, 9
	Reducing tap well	15/25	K650RTW	N1, 7, 8, 9
	Loadbreak elbow tap plug	15	650ETP	N1, 7, 8, 10
		25	K650ETP	N1, 7, 8, 10
		35	750ETP	N1, 7, 8, 10
	Vault stretcher threaded stud	15/25	650VSA	N1
		35	750VSA	N1
	600 Series elbow threaded stud	15/25	650SA	N1
		35	750SA	N1
	Assembly tool (window-op)	All	600ATM	-
	Spanner wrench	All	600SW	N9
	Direct voltage test meter adapter for: HD electric meters	All	200TC-1	N12
	Ross meters		200TC-2	N12
	Chance meters		200TC-4	N12

N1. For 900 A ratings, substitute 675 for 650 and 655; 676 for 656; K671 for K651; K675 for K650 and K655; K676 for K656; 775 for 750 and 755; 776 for 756 and 2X for 0X in the catalog number. The 900 A rating requires copper current-carrying connector components and copper conductor cable.

N2. Add suffix symbol from page A17 to include cable shield grounding kit and/or cable jacket sealing kit.

N3. Available without the stud by adding "N" to the catalog number.

N4. Straight receptacle adapter is used to connect straight receptacles K655YBSR and K655YSR-W0X (page A33) to equipment bushings.

N5. Aluminum lug for use on aluminum or copper conductors. DO NOT substitute threaded 03600X lug.

N6. Copper lug for use on COPPER CONDUCTOR ONLY. DO NOT substitute threaded 03602X lug.

N7. Available with the stud factory-assembled by adding "SP" to the catalog number. 675ETP, K675ETP and 775ETP are available as -SP only. The stud is not field removable.

N8. Available with a loose stud by adding suffix "S" to the catalog number.

N9. 600SW spanner wrench is recommended for installation of deadbreak reducing tap plugs and reducing tap wells.

N10. Use 600ATM assembly tool.

N11. 600 Series elbows and straight receptacles with IEEE Std. 386 capacitive test points are available by substituting 656 for 655; K656 for K655; K676 for K675; 756 for 755; 676 for 675; K676 for K675 and 776 for 775 in the catalog number.

N12. Direct test connectors, along with a 200TC-X series meter adapter, a properly rated voltage meter and hot-line stick; provides a means for direct conductor voltage testing.

N13. With stainless steel bracket.

N15. Available with 200 KV BIL adding suffix "-200".

N16. Bimetallic lug for use on aluminum or copper conductors. DO NOT substitute threaded 05501X lug.

Refer to the W and X tables on pages A54-A55 for sizing to cable insulation diameter and conductor size. For cable shield adapters and jacket seals, see pages A44-A45.