

**Operation Instructions  
BTSB Test Set**

---

**BTSB Test Set**

**(Benchtop Trip Simulator for Breakers)**

For Breakers with MPS-C and MPSC-2000 Trip Units



**ABB**

# Table of Contents

INTRODUCTION.....	4
BASIC HANDLING AND CARE .....	4
PRIMARY FEATURES.....	4
RUNNING A TEST - The Quick Course.....	4
RUNNING A TEST - The Details.....	5
Connecting the BTSB.....	5
The Initial Power-Up Screens.....	5
The SETTINGS Menu .....	5
1-Test Type.....	5
2-Date & Time.....	6
3-View Settings.....	6
The TEST Screen.....	6
VIEWING TEST RESULTS .....	7
The DATA Menu.....	7
View Data .....	7
Download Data.....	7
Delete .....	8
The PRINT Menu.....	8
INTERPRETING TEST RESULTS.....	8
ADJUSTMENTS, CALIBRATION, SERVICE.....	9
The Battery.....	9
LCD Screen Contrast .....	9
Calibration .....	10
Amps .....	10
Volts.....	10
Timing.....	10
Service and Technical Support.....	10
<b>FIGURES</b>	
1 BTSB Controls and Features.....	11
2 Amperage Calibration Test Schematic.....	9
3 Voltage Calibration Test Schematic .....	9
4 Timing Calibration Test Schematic.....	9
5 BTSB Menu Schematic .....	16
<b>TABLES</b>	
1 Available Test Types .....	12
2 BTSB Data Record Structure .....	13
3 Settings & Delay Times for Delay Tests.....	13
4 BTSB Error Codes.....	14
5 BTSB Error Correction Notes .....	14
6 Settings for testing MPS-C type devices .....	15

NOTE: This Instruction Book is provided solely for the convenience of the purchaser, and does not purport to cover all details or variations in equipment nor to provide for every possible contingency to be met in connection with installation, operation, or maintenance. Should further information be desired or should particular problems arise which are not covered sufficiently for the purchaser's purposes, the matter should be referred to the nearest Sales Representative.

## INTRODUCTION

The Benchtop Trip Simulator for Breakers (herein referred to as the BTSB) is a microprocessor driven secondary current/voltage injection test set specifically designed for use with the MPS-C and MPSC-2000 solid state trip devices (hereafter referred to generically as MPSC's). The BTSB can test all facets of MPSC operation, including the following:

- Instantaneous Threshold
- Short Time Threshold & Delay
- Long Time Threshold & Delay
- Ground Threshold & Delay
- Current Metering Accuracy
- Voltage Metering Accuracy (MPSC-2000 only)
- Self-Power Level Verification

Altogether, the BTSB can perform up to 35 tests on an MPSC, and all tests are performed by true secondary current or voltage injection. There are also built-in calibration tests which can be performed to ensure that the BTSB is providing accurate results.

## BASIC HANDLING AND CARE

The BTSB should require no adjustments or maintenance during its life other than those items mentioned herein.

Because the BTSB is essentially a portable computer with a built-in audio-quality power amplifier, it should be handled with the same care afforded similar equipment (e.g., laptop computers, oscilloscopes, etc.). The BTSB was designed for field use, but excessively rough handling may damage the unit.

## PRIMARY FEATURES

1. The BTSB uses true secondary current/voltage injection, which tests the input and conditioning circuits of the MPSC, as well as the A/D conversions, communication hardware, and all software (protection, metering, and communication).
2. The BTSB automatically sets up the MPSC-2000 for each test, performs the test, and resets the MPSC-2000 to its original settings following the test. When testing an MPS-C trip device, the user is prompted to make the correct front panel settings for each test.
3. The BTSB maintains in battery-backed RAM the

results of the most recent 1,500 tests, which can be reviewed on the BTSB's LCD screen, sent to an ASCII printer attached to the BTSB's parallel port (Figure 1, Item 3), or downloaded to a PC connected to the BTSB's serial port (Figure 1, Item 2).

4. As part of the data storage records, the user may input a "Reference Number" for each set of tests. Later, this number can be used to easily retrieve results for specific tests or trip units, even if the requested records are spread throughout the database.

## RUNNING A TEST - The Quick Course

**WARNING WARNING WARNING WARNING**

**Do not test breakers in the switchgear unless they have been racked to the TEST or DISCONNECTED position.**

If you are familiar with the MPSC and the BTSB, the following brief instructions may be used to conduct a

**WARNING WARNING WARNING WARNING**

**Securely fasten the test cables to the MPSC and do not disconnect them during testing. Voltage will be present, which could cause injury to personnel or damage to equipment.**

test:

Prior to powering up the BTSB, it must be connected to an MPSC in accordance with these instructions. Once the BTSB is properly connected and the power switch is turned on, the unit will perform the initial setups and checks that are required prior to testing.

Pressing the TEST button at the MAIN MENU will show the currently selected settings. At this point, pressing the Enter key (+) will begin the testing.

The BTSB will automatically set up the MPSC-2000, perform the tests, and record the results. If the unit being tested is an MPS-C, the user will be prompted to

**WARNING WARNING WARNING WARNING**

**The BTSB will attempt to return the MPSC-2000 to its original setting following testing, but unforeseen occurrences such as aborted tests may leave the trip device in an unknown state. The user must verify that the trip device settings are correct prior to placing the unit back into service.**

make changes to the trip unit's front panel settings when required.

Following testing, the BTSB will present a summary screen of the test results. In addition, the test results may be viewed by choosing either DATA or PRINT from the MAIN MENU, depending on whether the data is to be viewed on the LCD screen or sent to a printer.

If the trip device "fails" any test, please review the section entitled "Interpreting the Results" later in this book before dispositioning the device.

## RUNNING A TEST - The Details

**WARNING WARNING WARNING WARNING**

**Do not test breakers in the switchgear unless they have been racked to the TEST or DISCONNECTED position.**

If you are not completely familiar with the operation of the BTSB and the MPSC, please review all of the

**WARNING WARNING WARNING WARNING**

**Securely fasten the test cables to the MPSC and do not disconnect them during testing. Voltage will be present, which could cause injury to personnel or damage to equipment.**

following prior to performing a test:

**Connecting the BTSB.** At a minimum, the communication and test cable must be connected to the MPSC prior to testing. Refer to the following instructions:

First, disconnect all cables from the MPSC. Depending on the exact configuration, there may be up to three plugs which must be removed. Be sure to save the plastic screws for reuse following testing.

The BTSB's communication and test cables must be attached as follows:

(1) The female DB-25 (Figure 1, Item 9) and DB-9 (Figure 1, Item 5) connectors must be fastened to the corresponding ports on the MPSC.

(2) If the device being tested is an MPSC-2000 which has a VIM board installed, the four-pin VIM plug (Figure 1, Item 7) must be connected adjacent to the two DB plugs. The BTSB cannot test the VIM on an MPS-C trip unit, and therefore connecting this plug to a VIM on an MPS-C will have no effect.

(3) The male DB-25 plug (Figure 1, Item 8) from the BTSB may be connected to the breaker harness that was disconnected from the MPSC above if the user wishes the breaker's magnetic latch to operate during testing. Otherwise, this plug may be left disconnected.

(4) Finally, the BTSB's power cable (Figure 1, Item 6) must be attached to an available 110/120VAC source. If a 220/240VAC source is used, the appropriate adapter must be installed and the voltage selector switch (Figure 1, Item 12) on the rear of the BTSB must be changed to read "230V".

**The Initial Power-Up Screens.** When power is turned on to the BTSB it will display a welcome screen, showing the software version. During this time, the BTSB will initialize itself.

Following this screen, the MAIN MENU will be displayed, and the user may continue by selecting one

### SETTINGS MENU

1-Test Type

2-Date & Time

3-View Settings ↩

of the four red main menu keys.

**SET - The SETTINGS Menu** - As the name implies, the settings menu allows the user to view and/or change the settings of the BTSB:

Pressing "1" (Test Type) brings up the following screen (Note: When certain keys are pressed, the BTSB will

TEST                      MAG  
↑    ALL                      ↑    On

communicate with the MPSC to determine the type and configuration of the trip unit - sensor rating, VIM status, present settings, etc. This information is stored for future use. If no trip device is attached, the user will be returned to the main menu.):

Using the above screen, the Test Type and magnetic latch settings may be changed. To determine which will be changed, make note of where the underline cursor is (in the above example, the Test Type is ready to be

changed). Use the left and right arrow keys (← and →) to manipulate the cursor to the desired feature, and then use the up and down cursor keys (↑ and ↓) to scroll through the available options. Pressing the Enter key (↵) at any time saves the presently viewed values

```
01-Jun-1998  14:25
↑↑
```

and returns to the previous screen.

2 - Date & Time. By selecting "2" from the Settings Menu, the user will be presented with a screen similar to the following:

Use the left and right arrow keys (← and →) to select the item to be changed, and then use the up and down arrow keys (↑ and ↓) to alter the selected value. Note that the hours must be entered in 24-hour format (e.g., 2:25 p.m. is shown correctly above as 14:25). After all values are correct, press Enter (↵) once to set the clock

```
PRESENT SETTINGS
Test:  ALL      MagOn
1600A MPSC-2000 v1.5
noVIM      60 Hz  ↵
```

and view the new time, and then again to return to the Settings Menu.

3 - View Settings. Selecting "3" from the Settings Menu will display a screen similar to the following:

(Note: If no trip device is attached, the user will be returned to the Main Menu.) In this screen, "Test" is the presently selected test type (see Table 1 for a description of available test types) "ALL" in this example indicates that all possible tests will be performed (35 tests on an MPSC-2000 trip unit with VIM; fewer on other devices). "MagOn" indicates that a trip signal generated by the MPSC during testing will be sent to the breaker's magnetic latch (assuming that the harnesses were properly attached as discussed above, and that the magnetic latch is reset); this feature can be disabled by the user, in which case the message will show as "MagOff". The third line provides a complete description of the trip device being tested, including the sensor rating of the breaker (i.e., the continuous current rating of the MPSC being tested), the device type, and

the software version of the trip device. In the fourth line, "noVIM" indicates that a VIM board is not present in the MPSC-2000 (Note: "noVIM" will always be displayed when an MPS-C is being tested, regardless of the presence of a VIM module), and therefore no voltage tests will be performed, even if "ALL" is selected. Finally, the frequency setting of the trip device is displayed (in this case, 60 Hz). As discussed earlier, only the magnetic latch setting and the test type may be changed by the user; the remaining values are established through communications with the MPSC, and cannot be varied by the user.

```
Test:  ALL      MagOn
Sensor: 1600A noVIM
Press ← to Begin
```

Pressing the escape key (␣) will return the user to the Settings Menu.

**TEST - The TEST Screen.** Once you press the TEST button, a screen similar to the following will be displayed:

As the screen indicates, the user may either press Enter (↵) to begin the testing, or Escape (␣) to return to the MAIN MENU.

If the user presses Enter at the above screen, the user will be requested to enter a Reference Number for the test. The **Reference Number** can be any number from 0 to 65535, and is used to facilitate retrieval and collation of test data in the future. For example, the user could enter the 4-digit MPSC serial number or a number that represents the breaker being tested. Then at some point in the future, the user can easily view or print all of the stored records for that unit.

After inputting the Reference Number, the BTSB will begin testing, and will print status messages on the LCD screen from time to time. When testing an MPS-C, the user will be instructed prior to each test to set the switches on the front panel of the unit to the proper

#### WARNING WARNING WARNING WARNING

The BTSB will attempt to return the MPSC-2000 to its original setting following testing, but unforeseen occurrences such as aborted tests may leave the trip device in an unknown state. **The user must verify that the trip device settings are correct prior to placing the unit back into service.**

BRK #

settings. Upon completion of all testing, the BTSB will display a brief summary of the test results, and will permit the user to view the records of any failed tests.

As the testing is being performed, the BTSB stores the results in battery-backed RAM. These results can be viewed using the DATA and PRINT menus. (NOTE: Up to 1,500 records can be stored in RAM. If less than 40 free records exist prior to performing a test, the oldest records will be deleted in blocks of 40.)

## VIEWING TEST RESULTS

After testing, the user will want to view the results of the tests to determine whether the trip device is functioning

```
DATA MAIN MENU
1-View          4-Print
2-Download      5-BTSB
3-Delete       ↩
```

correctly. From the MAIN MENU screen, data can be viewed by depressing either the DATA key or the PRINT key.

**The DATA MENU.** The DATA MAIN MENU provides five options:

**View:** the data records can be viewed on the BTSB's LCD screen.

**Download:** the records can be downloaded to a PC.

**Delete:** some or all records can be deleted.

**Print:** this option is the same as pressing the PRINT button at the MAIN MENU.

```
VIEW DATA ON LCD
1-For a Ref. No.
2-For a Date
3-By Record No.  ↩
```

**BTSB:** displays the BTSB's serial number and software version, and the backup battery voltage.

The View Data Menu permits the user to display stored test records on the BTSB's LCD screen. (See Table 2

for a description of the BTSB's test record structure.)

1-For a Ref. No. The user will be prompted to enter a Reference Number. Scrolling with the up and down arrow keys (↑ and ↓) will permit viewing of all records with that reference number.

2-For a Date. The user will be prompted to enter a specific date, and can then view all matching records using the up and down arrow keys (↑ and ↓).

```
# 4          Ref: 1234
LT-Threshold-PhA
Pass 14-May-1998
Picked up at 1620A
```

3-By Record Number. The user will enter a specific record number, and can then view all records by scrolling with the up and down arrow keys (↑ and ↓).

Regardless of the criteria used, the record screen will be similar to the following:

The first line contains the record number and the Reference Number. The second line shows the Test Type. The third line displays the test result (pass or fail) and the date of the test. The bottom line contains the remarks applicable to the test, which will normally consist of details of the test results (delay time, pickup point, etc.).

At any point during the use of this screen, the user may press the Escape key (↵) to return to the viewing menu. Scrolling up or down (↑ or ↓) will show the previous or next record in the selection, respectively. Scrolling past either end of the data selection will "wrap" to the other end of the selection (e.g., scrolling past the last record will cause the first record in the selection to be displayed). Due to the size of the LCD display, only 20 characters of the remark field can be shown at a time on the bottom line; the remainder of the remark field may be viewed by scrolling left and right (← and →).

**Download Data.** To use this feature, the user must have a PC with an available serial (COM) port and a terminal software package such as HyperTerminal. Set the communications to 38,400 baud, 8 bit, no parity, 1 stop bit (consult the terminal program's manual or help function for details on how to set these parameters), and connect a serial cable (wired straight through) from the PC's serial port to the BTSB's serial port (Figure 1, Item 2). Set the terminal software to capture text to a file (e.g., testdata.txt). On the BTSB, hit the Enter key to transmit the data. When the data has all been

received, turn off the capture feature on the PC to close the file and review the captured data file to ensure that it was properly received. The text file can now easily be imported into a spreadsheet program such as MS Excel, Lotus 1-2-3, or MS Works (consult the instructions or help screens for the spreadsheet program for details).

The Delete screen permits the user to delete selected records from the BTSB's RAM. The BTSB can store up to 1,500 records, and from time to time the user may wish to delete obsolete or insignificant data. During normal operation the BTSB will automatically delete the oldest records (in blocks of 40) to make space available for new test records when the RAM becomes full.

```
1275 records exist
Enter #'s to Delete
First Rec. No. 875
Last Rec. No. 889
```

```
15 records
will be deleted
← to delete
```

Therefore, unless there are specific records that the user wishes to delete, the manual deletion process need not be employed.

```
PRINT MAIN MENU
1-Use a Ref. No.
2-Use a Date Range
3-Use Record Nos. →
```

If the delete process is selected, the user will be prompted to enter a range of record numbers to delete, and then will have the option to escape from the deletion process as shown in the accompanying screen samples.

**The PRINT Menu.** The Print Menu works in much the same way as the View Menu. Data can be sent to an ASCII printer connected to the

BTSB's parallel printer port. The data can be selected from the entire set of stored records by reference number, date range, or record number range.

#### Printing Notes:

Keep in mind that for legibility just 17 records are printed per page. Therefore, if the memory is full (1,500 records) and all records are requested, 89 pages will be printed. It is strongly recommended that the user employ a meaningful Reference Number system to assist in the printing of records.

If the BTSB "hangs" during printing and/or nothing is coming out of the printer, make sure that the printer is on-line and full of paper. The BTSB cannot resolve errors of this type when printing, and the printing process may "hang" or have to be repeated.

The BTSB prints using standard ASCII, and does not attempt to send control codes to the printer. The printed lines are less than 80 characters long. A fixed-pitch font that is approximately 12 points (10 pitch) is recommended for best results.

The printing routines have been successfully tested on the following types of printers:

HP LaserJet 5P  
HP DeskJet 1200C

Printing may not function correctly with some older printers, especially dot matrix printers. For example, the following printer is not compatible with the BTSB:

Okidata Microline 391 Plus

## INTERPRETING TEST RESULTS

Interpreting the results of the testing is typically straightforward: if all of the test records indicate "Pass" in the Result field, then the trip device is operating correctly. However, there will occasionally be instances where the BTSB will report a failure on one or more tests. In such an instance, please review the following prior to replacing the trip device or having it serviced:

Delay Tests. Carefully review the tests that were "failed", and compare those results with the results of similar tests that were performed on the same device and with the acceptance criteria provided in Table 3. Is the amount of the deviation significant? If not, then perhaps the trip device is operating properly, but other factors caused the out-of-tolerance condition. For example, if a trip device trips in 0.65 seconds versus a maximum requirement of 0.64 seconds and all of the

other tests were within specification, then it can safely be assumed that the device is functioning correctly. Delay tests on the Ground Module are particularly susceptible to this problem due to the relatively low test currents involved.

**Threshold Tests.** Threshold tests, especially on the Instantaneous Module, can vary significantly from one test to another. Consistently significant deviations from specification may indicate a problem, while occasional deviations are likely due to random influences.

### Other Notes and Tips:

It is recommended that the user repeat any test(s) that is out of specification, noting whether the results remain consistent. If the results of the repeated test are acceptable, then it can be assumed that some external influence (for example, an abrupt change in the supply voltage to the BTSB during testing) probably caused the initial failure.

If most or all of the trip devices being tested are "failing", then it is possible that the problem lies within the BTSB. Perform the calibration checks in the next section to verify that the BTSB is operating correctly.

## ADJUSTMENTS, CALIBRATION, SERVICE

**The Battery.** There is only one user-serviceable part inside the BTSB: the lithium battery that maintains the RAM; under normal conditions, the battery will last 3 to 4 years before it needs to be replaced. The battery is a high energy lithium 3.6V size AA (Tadiran TL-5903 or equivalent).

The BTSB checks the status of the battery every time the power is turned on, and a message will appear reminding the user to replace the battery when the battery voltage falls below 3.24V (90% of 3.6V). (Note: The battery voltage can be checked at any time by selecting "BTSB" under the DATA menu.) Prior to replacing the battery, the user should print or download any data records that are important. **All data in RAM will be lost during battery replacement.** The BTSB's software is in Flash Memory, and will not be affected.

To replace the battery, disconnect the BTSB from all power sources, remove the four screws that secure the top panel, and remove it from the case. Replace the battery, and reassemble the top panel into the case.

Following battery replacement, all settings that were made from the front panel will have to be re-set, such as the test type, magnetic latch on/off, and date/time.

**LCD Screen Contrast.** The BTSB's LCD screen is

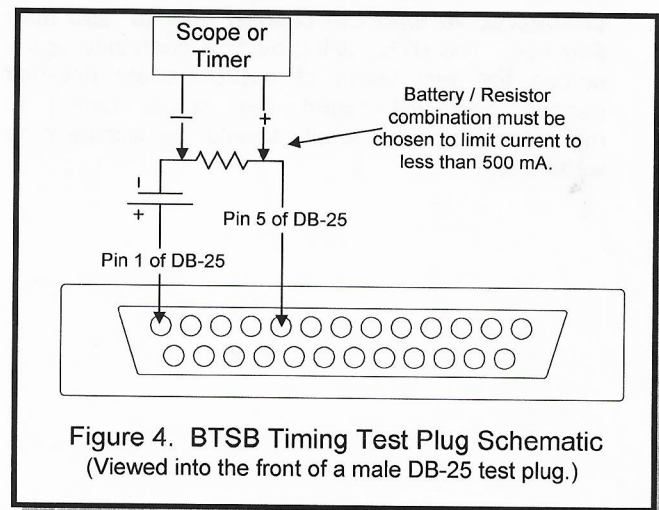
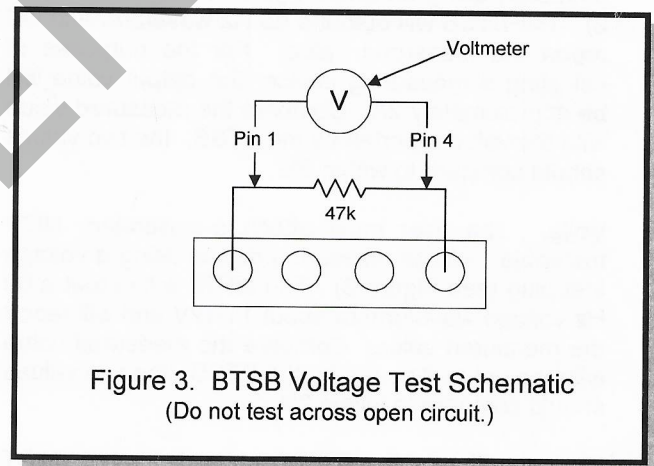
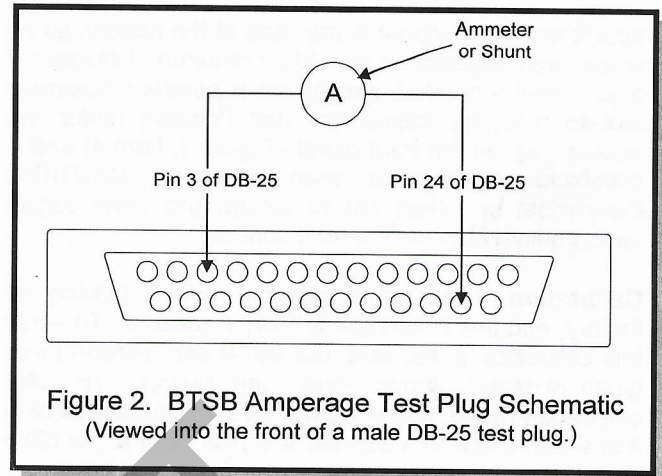



backlit and the contrast is adjusted at the factory, so no subsequent adjustment should be required. However, if adjustment is needed, simply use a **plastic** adjustment tool to turn the adjustment dial (located under the access plug on the front panel - Figure 1, Item 4) until a satisfactory setting has been achieved. **CAUTION:** Care must be taken not to disturb the small toggle switch adjacent to the contrast control.

**Calibration.** The BTSB is calibrated prior to leaving the factory, and this calibration is NIST traceable. To verify this calibration in the field, the BTSB can perform three types of tests: Amps, Volts, and Timing. To enter calibration mode, power up the BTSB without attaching it to a trip device and depress the TEST key at the Main Menu.

**Amps.** The user must attach a calibrated, NIST traceable, current-measuring device (e.g., a shunt or ammeter) using an amperage test plug (see Figure 2). The BTSB will output a 60 Hz waveform and will report the measured value. For the purposes of selecting a measuring device, the output value will be approximately 2A. Compare the measured value with the value reported by the BTSB; the two values should compare to within 2%.

**Volts.** The user must attach a calibrated, NIST traceable, voltage-measuring device using a voltage test plug (see Figure 3). The BTSB will output a 60 Hz voltage waveform of about 11-12V and will report the measured value. Compare the measured value with the value reported by the BTSB; the two values should compare to within 2%.

**Timing.** The user must attach a calibrated, NIST traceable, time-measuring device (such as an oscilloscope) using a timing test plug (see Figure 4) and a suitable voltage source (e.g., a 9V battery). **Please note that the voltage source must be configured to limit the current flow to less than 500 mA.** The BTSB will provide a continuity signal across the test leads of approximately one-half second and will report the actual timing in milliseconds. The result should be accurate to within 2%.

While performing the Amperage and Voltage calibration checks, the user may press the Escape key (⏏) at any time to end the test. Otherwise, the Amperage and Voltage tests will automatically cease after 30 seconds.

If the BTSB fails any of these tests, it most likely will need servicing, which will require that it be returned to the factory. Please refer to the following section for service contacts at ABB.

**Service & Technical Support.** Technical questions, requests for information, suggested improvements, etc., may be sent via e-mail to:

**BTSB@ustra.mail.abb.com**

Service and warranty issues should be directed to the ABB DSD post-order service department at:

**(800) 634-7643**

Price quotes and other types of information may be obtained from the ABB DSD Sales and Marketing Group:

**(800) 338-1585**

General help and referrals to specific contact points within ABB can be obtained from the ABB Help Desk:

**(800) 626-4999**

**Figure 1 - Controls and Features**

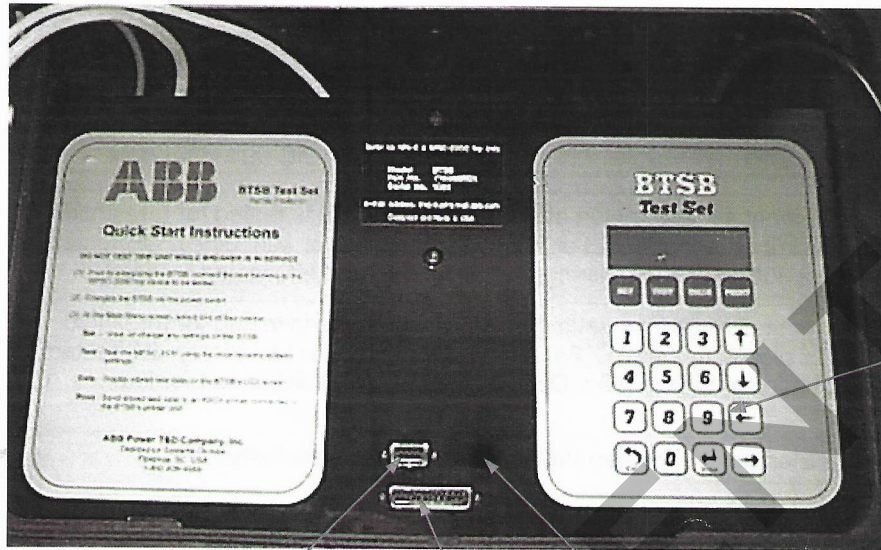

**Top View**

- 1 - Keypad
- 2 - Serial Port
- 3 - Parallel Port
- 4 - Access port for LCD contrast

2 3 4

**Rear View**

(shown removed from the case for clarity)

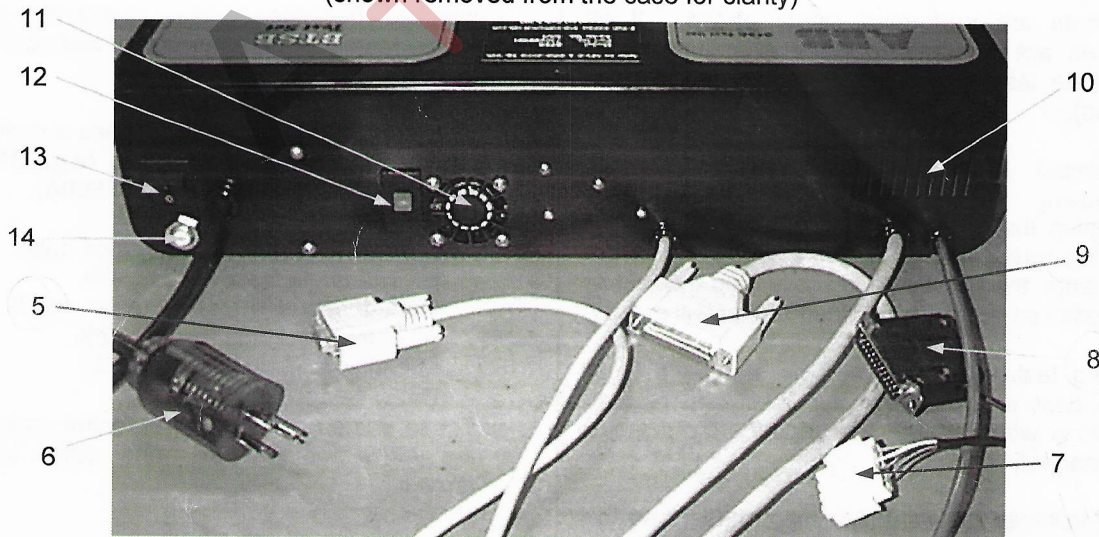

- 5 - DB-9 Communications Cable
- 6 - Input Power Cable
- 7 - Four-pin VIM Connector
- 8 - Male DB-25 (connects to breaker harness)

- 9 - DB-25 Main Test Cable
- 10 - Air Intake
- 11 - Cooling Fan
- 12 - 115V/230V Input Voltage Selector Switch

**Table 1. Available Test Types**

<b>Symbol</b>	<b>Description</b>	<b>Phases Tested <sup>(1)</sup></b>
Inst	Instantaneous Trip Element. Tested at 100% of 3X Inst setting for pickup threshold.	Each phase is tested.
ST/DF or ST/IT	Short Time Trip Element set at 2X. Tested at 100% of 2X for pickup threshold and 150% for delay timing. (DF = DEF, /IT = I <sup>2</sup> t)	Each phase is tested for threshold. ØA tested for Min. delay, ØB tested for Int., and ØC tested for Max.
LT	Long Time Trip Element set and tested at 100% of 1X setting for pickup threshold. Set at ½ of rating and tested at 300% for delay timing.	Each phase is tested for threshold. ØA tested for Min. delay, ØB tested for Int., and ØC tested for Max.
GND/D or GND/I	Ground Trip Element set to various settings. Tested at 100% for pickup threshold. See Table 3 for delay timing settings. (/D = DEF, /I = I <sup>2</sup> t)	Each phase is tested for threshold. ØA tested for Min. delay, ØB tested for Int., and ØC tested for Max.
Volts	Voltage Metering Element (only when VIM is installed). <sup>(4)</sup>	Each phase is tested.
Amps	Current Metering Element. Tested at approx. 50%, 100%, and 200% of breaker sensor rating.	Each phase is tested.
PwrUp	Tested to ensure that the trip device will power up at 20% of rated current on a single phase.	Each phase is tested.

**NOTES:**

- (1) All tests are performed single phase. If all phases are required to be tested, then three separate tests will be performed (one on each phase).
- (2) Threshold tests are performed by steadily increasing the test current until the MPSC indicates that it has “picked up” and begun the tripping process. For tests on Long Time elements, the BTSB will typically stop the test at this point so no tripping of the breaker will occur.
- (3) Timing tests are performed by starting a timer coincident with the flow of current and reading the timer when the MPSC sends the trip pulse to the magnetic latch.
- (4) Test voltages are actually single phase, and the readings being checked by the BTSB are equivalent to 3-phase voltages of approximately 240, 480, and 600VAC, respectively.
- (5) If the selected test type is “ALL”, then all of the applicable tests will be performed for a total of 35 tests on an MPSC-2000 which has a VIM board installed. For other devices, all available features will be tested, but the number of tests will be less than 35.
- (6) The term “X” used above indicates a multiplier of the presently applicable setting (e.g., 3X would equal 2400A on a breaker set to 800A).
- (7) **Acceptance Values** (for reference only)
  - LT Threshold tests: +12%, -2%
  - Instantaneous Threshold tests: -15%, +12%
  - All other Threshold tests: ±12%
  - Metering Accuracy tests: ±5%
  - Delay tests: (See Table 3)
 These values account for potential variances in the MPSC, the BTSB, and other influential factors.

**Table 2. BTSB Data Record Structure**

<u>Field</u>	<u>Description</u>	<u>Typical Values</u>
Reference Number	A user-supplied number, used to facilitate easy data retrieval.	Must be between 0 and 65535 (inclusive).
Date & Time	The system date and time at which the test was conducted.	date: dd-mmm-yyyy time: hh:mm (24-hr format)
Test Type	Test type, sub-type, and the phase tested.	See Table 1 for Test Types. Sub-types include Threshold, Delay, and %Accuracy.
Device Type	Type of trip device, sensor rating, software version, frequency setting, and whether a VIM is installed.	e.g., "800A MPS-C-5G v1.5 noVIM 60Hz" or "1600A MPSC-2000 v1.3 VIMon 60Hz"
Result	The bottom-line result of the test.	"Pass" or "Fail" ("—" indicates an aborted test)
Remarks	Details of the test.	Typically, the actual test data will be included, as applicable; for example: "Picked up at 812A (+1.5%)"

**Table 3. Settings and Delay Times for the Delay Tests performed by the BTSB.**

Trip Element	Setting	Test Value	Min. Setting (sec.)	Int. Setting (sec)	Max. Setting (sec)
Short Time (DEF)	2X	150% of	0.08 - 0.17	0.20 - 0.32	0.35 - 0.50
Short Time (I <sup>2</sup> t)	2X	150% of	0.15 - 0.25	0.45 - 0.78	0.85 - 1.35
Long Time	1X (Low)	300% of	7.5 - 13	19 - 33	60 - 100
Ground (DEF)	Same as I <sup>2</sup> t	Same as I <sup>2</sup> t	0.05 - 0.18	0.20 - 0.32	0.35 - 0.50
Ground (I <sup>2</sup> t)	See Below	See Below	See Below	See Below	See Below

**Settings and Delay Times for Ground Tests using the I<sup>2</sup>t trip curve.**

Sensor Rating	Setting	Test Value	Min. Setting (sec.)	Int. Setting (sec)	Max. Setting (sec)
200A or 600A	100A	200A	1.6 - 2.5	5.0 - 7.9	12 - 19
800A	100A	300A	0.7 - 1.1	2.3 - 3.4	5.4 - 8.2
1600A - 2000A	300A	700A	0.13 - 0.22	0.41 - 0.64	1.0 - 1.6
2500A	300A	900A	0.08 - 0.18	0.25 - 0.40	0.60 - 0.95
3000A - 4200A	500A	1200A+	0.05 - 0.18	0.20 - 0.32	0.35 - 0.50

**Error Codes and Error Correction Notes.** The following tables provide the error codes used by the BTSB during normal operation. Some error codes are automatically corrected by the BTSB, while others will cause the software to halt with the offending error code displayed. Refer to Table 4 for a brief description of the error, then use the letters in parentheses following each description to determine the recommended actions to be taken. For best results, refer to the notes in Table 5 in the order that they are provided in Table 4.

**Table 4. BTSB Error Codes**

- |   |  |
|---|--|
| 1 No trip device is connected. (a, b)   | 8 Data Acquisition Error. The data acquisition did not stabilize with the required time. (d)         |
| 2 Ground Module Error. Either no ground module is installed, or the ground module code returned by the MPSC is not recognized by the BTSB. No testing can be performed. (a, b, c) | 9 MPSC Amps Error. The amperage values being returned by the trip device are not meaningful. (a, d)  |
| 3 Un-known trip device. The BTSB received a response from the trip device, but cannot understand it. (a, b)   | 10 MPSC Volts Error. The voltage values being returned by the trip device are not meaningful. (a, d) |
| 4 Status Error (PwrUp routine). (d)   | 11 Flash memory error. (d)   |
| 5 Checksum Error. The response from the trip device contained an incorrect checksum. (a)  | 12 Calibration values are corrupt. (d)   |
| 6 Low Battery. (e)  |  |
| 7 Current Setting Error. The BTSB could not set the target current within a reasonable time. (a, d)   |  |

**Table 5. BTSB Error Correction Notes**

- |   |  |
|---|--|
| a Turn off the BTSB, verify that all connections to the trip device are correct, power up the BTSB, and try the test again.                                       |  |
| b Only MPS-C and MPSC-2000 type trip devices may be tested with the BTSB. Do not attempt to test MPS, SS, or trip devices from other manufacturers with the BTSB. |  |
| c Contact ABB to ensure that your BTSB has the latest available software version.   |  |
| d Contact ABB technical support for assistance.   |  |
| e Replace the battery at the next convenient time, using the instructions in this Bulletin.   |  |

**TABLE 6 - Settings for testing MPS-C-3, MPS-C-3G, MPS-C-4, MPS-C-4G, MPS-C-5, and MPS-C-5G**

(Note: Some settings will not be applicable to certain types of trip device.)

TEST DESCRIPTION	INST	TEST	GROUND PICKUP	GROUND DELAY	GROUND I <sup>2</sup> T	SHORT TIME SETTING	SHORT TIME DELAY	SHORT TIME I <sup>2</sup> T	LONG TIME SETTING	LONG TIME DELAY	AMPS
Inst-Threshold (all phases)	3	INST	---	---	---	---	---	---	---	---	(Highest)
ST-Threshold (all phases)	---	ST	---	---	---	2	MIN	OUT	---	---	(Highest)
ST/DF-MIN Delay-PhA	---	ST	---	---	---	2	MIN	OUT	---	---	(Highest)
ST/DF-INT Delay-PhB	---	ST	---	---	---	2	INT	OUT	---	---	(Highest)
ST/DF-MAX Delay-PhC	---	ST	---	---	---	2	MAX	OUT	---	---	(Highest)
ST/IT-MIN Delay-PhA	---	ST	---	---	---	2	MIN	IN	---	---	(Highest)
ST/IT-INT Delay-PhB	---	ST	---	---	---	2	INT	IN	---	---	(Highest)
ST/IT-MAX Delay-PhC	---	ST	---	---	---	2	MAX	IN	---	---	(Highest)
LT-Threshold (all phases)	---	LT	---	---	---	---	---	---	1.0	MIN	(Highest)
LT-MIN Delay-PhA	---	LT	---	---	---	---	---	---	1.0	MIN	(Lowest)
LT-MIN Delay-PhA	---	LT	---	---	---	---	---	---	1.0	INT	(Lowest)
LT-MIN Delay-PhA	---	LT	---	---	---	---	---	---	1.0	MAX	(Lowest)
Gnd-Threshold	---	GND	(see LCD)	MIN	OUT	---	---	---	---	---	---
GND/DF-MIN Delay-PhA	---	GND	(lowest)	MIN	OUT	---	---	---	---	---	---
GND/DF-INT Delay-PhB	---	GND	(lowest)	INT	OUT	---	---	---	---	---	---
GND/DF-MAX Delay-PhC	---	GND	(lowest)	MAX	OUT	---	---	---	---	---	---
GND/IT-MIN Delay-PhA	---	GND	(lowest)	MIN	IN	---	---	---	---	---	---
GND/IT-INT Delay-PhB	---	GND	(lowest)	INT	IN	---	---	---	---	---	---
GND/IT-MAX Delay-PhC	---	GND	(lowest)	MAX	IN	---	---	---	---	---	---
PwrUp (all phases)	---	---	---	---	---	---	---	---	---	---	---
Amp Metering (all phases)	12	---	(highest)	MAX	---	10	MAX	---	1.0	MAX	(Highest)

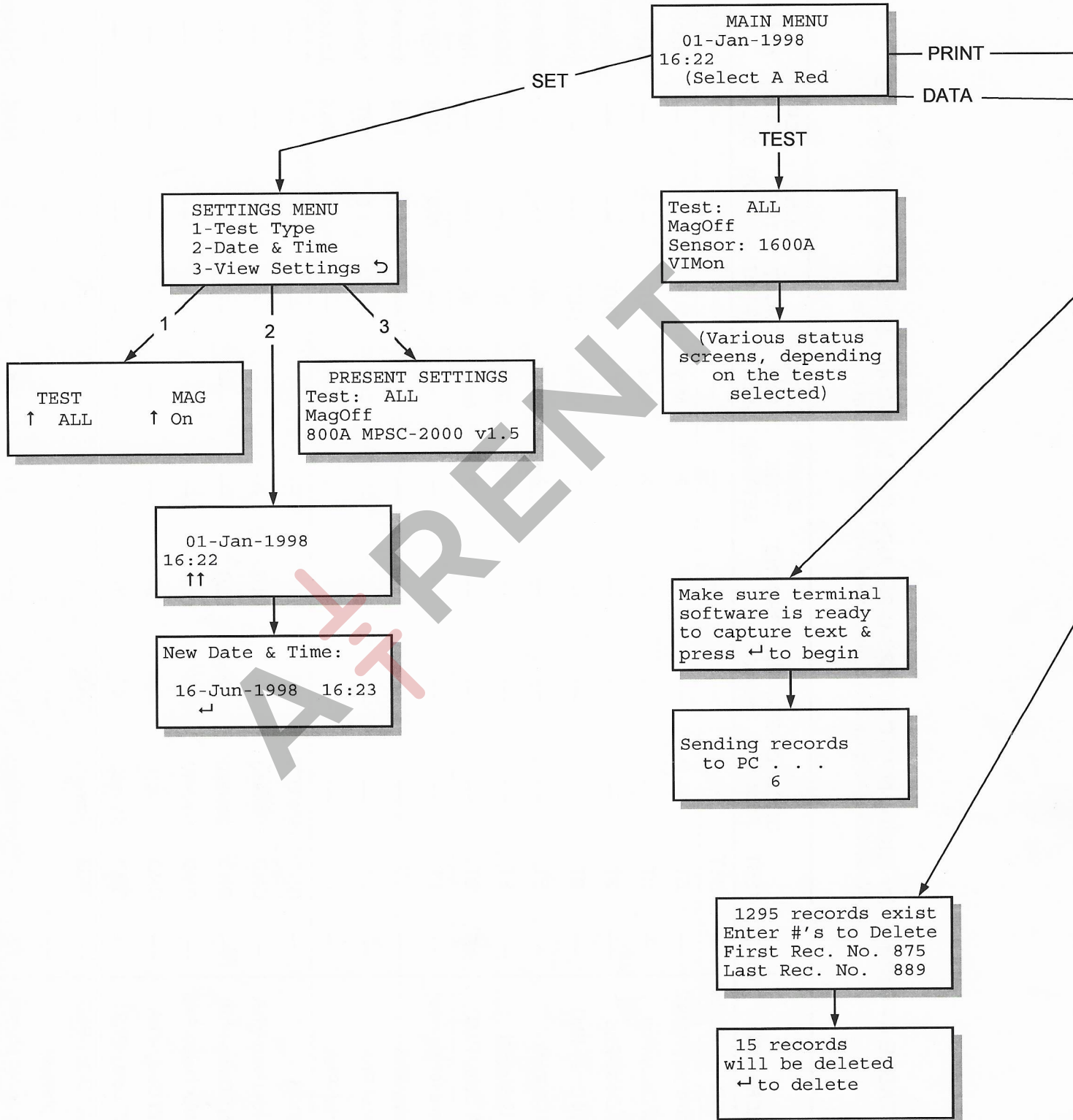

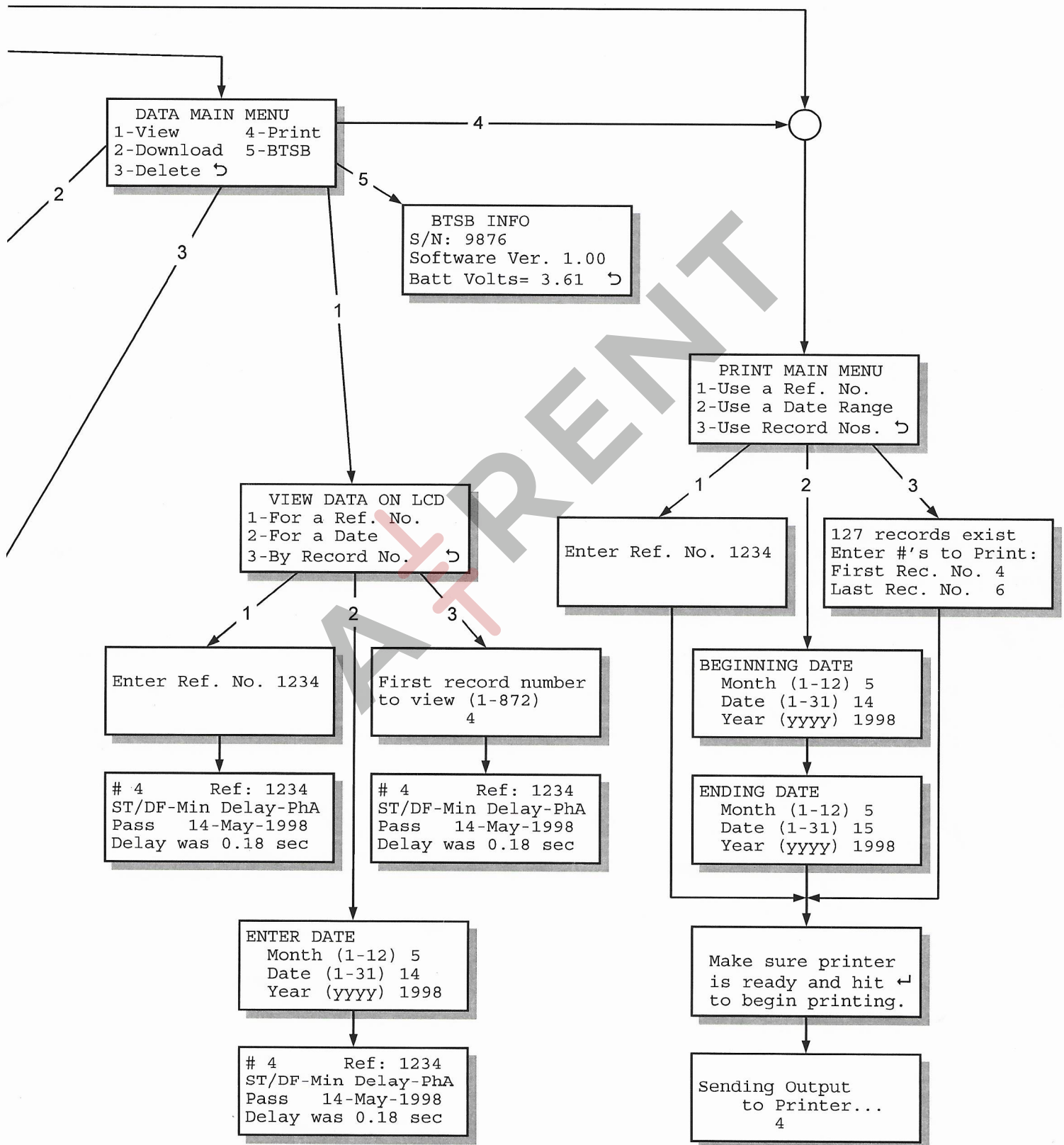



---

NOTES:

A++RENT

A-RENT

# ABB

---

ABB Inc.  
P.O. Box 100524  
Florence, South Carolina 29501

Phone: (843) 413-4700  
Fax: (843) 413-4850

**A-RENT**

[a-rent.com](http://a-rent.com)

(IL) 630.748.8900  
(TX) 713.564.8900

[sales@a-rent.com](mailto:sales@a-rent.com)